



E-CODER®)R900i™  
Installation and Maintenance Guide





E-CODER®)R900i™  
Installation and Maintenance Guide

## Copyright

This manual is an unpublished work and contains the trade secrets and confidential information of Neptune Technology Group Inc., which are not to be divulged to third parties and may not be reproduced or transmitted in whole or part, in any form or by any means, electronic or mechanical for any purpose, without the express written permission of Neptune Technology Group Inc. All rights to design or inventions disclosed herein, including the right to manufacture, are reserved to Neptune Technology Group Inc.

Neptune engages in ongoing research and development to improve and enhance its products. Therefore, Neptune reserves the right to change product or system specifications **without** notice.

## Trademarks Used in this Manual

ProRead and E-CODER are a trademarks of Neptune Technology Group Inc. R900 is a registered trademark of Neptune Technology Group Inc. E-CODER)R900*i* is a trademark of Neptune Technology Group Inc. Other brands or product names are the trademarks or registered trademarks of their respective holders.

## FCC Notice

This device complies with Part 15 of the FCC Rules. Operation is subject to the following two conditions:

- This device may not cause harmful interference.
- This device must accept any interference received, including interference that may cause undesired operation.

**Note:** This equipment has been tested and found to comply with the limits for a Class B digital device, pursuant to Part 15 of the FCC Rules. These limits are designed to provide reasonable protection against harmful interference in a residential installation. This equipment generates, uses, and can radiate radio frequency energy, and if not installed and used in accordance with the instructions, may cause harmful interference to radio communications. However, there is no guarantee that interference will not occur in a particular installation. If this equipment does cause harmful interference to radio or television reception, which can be determined by turning the equipment off and on, the user is encouraged to try to correct the interference by one or more of the following measures:

- Reorient or relocate the receiving antenna.
- Increase the separation between the equipment and receiver.

## RF Exposure Information

This equipment complies with the FCC RF radiation requirements for uncontrolled environments. To maintain compliance with these requirements, the antenna and any radiating elements should be installed to ensure that a minimum separation distance of 20 cm is maintained from the general population.



Changes or modifications not expressly approved by the party responsible for compliance could void the users' authority to operate the equipment.

## Professional Installation

In accordance with section 15.203 of the FCC rules and regulations, the Meter Interface Unit (MIU) must be professionally installed by trained meter installers. Changes or modifications not expressly approved by the party responsible for compliance void the user's authority to operate the equipment.

## Industry Canada

This Class B digital apparatus meets all requirements of the Canadian Interference Causing Equipment Regulations. Operation is subject to the following two conditions:

- This device may not cause harmful interference.
- This device must accept any interference received, including interference that may cause undesired operation.

Cet appareillage numérique de la classe B répond à toutes les exigences de l'interférence canadienne causant des règlements d'équipement. L'opération est sujette aux deux conditions suivantes: (1) ce dispositif peut ne pas causer l'interférence nocive, et (2) ce dispositif doit accepter n'importe quelle interférence reçue, y compris l'interférence qui peut causer l'opération peu désirée.

E-CODER®)R900i™  
*Installation and Maintenance Guide*  
Literature No. IM E-CODER)R900i 12.18  
Part No. 12560-002

Copyright © 2006 - 2018  
Neptune Technology Group Inc.  
All Rights Reserved.

Neptune Technology Group Inc.  
1600 Alabama Highway 229  
Tallahassee, AL 36078  
Tel: (800) 633-8754  
Fax: (334) 283-7293

<b>Chapter 1: Product Description</b> .....	<b>1</b>
E-CODER®)R900i™ Programming .....	2
<b>Chapter 2: Specifications</b> .....	<b>3</b>
Electrical Specifications .....	3
E-CODER®)R900i™ Dimensions .....	4
<b>Chapter 3: Installing the E-CODER®)R900i™</b> .....	<b>5</b>
Prior to Installation .....	5
Storage .....	5
Unpacking .....	5
Safety and Preliminary Checks .....	5
Site Selection .....	6
Installing the E-CODER®)R900i™ .....	6
New Meter Installation .....	6
Retrofit Meter Installation .....	7
Connecting the E-CODER®)R900i™ Through-the-Lid Antenna .....	7
Installing the Antenna .....	8
Attaching the Antenna to the MIU .....	9
<b>Chapter 4: Activating and Reading the E-CODER®)R900i™</b> .....	<b>11</b>
Activating the LCD Using the Solar Panel .....	11
Read the Meter .....	12
Common Causes of Leaks .....	13
How to Tell if Water is in Use .....	14
What to Do if There is a Leak .....	14
If a Continuous Leak is Repaired .....	14
If an Intermittent Leak is Repaired .....	14

*Chapter 5: Data Logging Extraction* ..... 15

    About Data Logging .....15

    Accessing Data Logging .....15

    Initiating RF Activated Data Logging ..... 20

        Sample Data Logging Graphs ..... 22

    Off Cycle Data Extraction ..... 23

        Belt Clip Transceiver .....24

*Chapter 6: Maintenance and Troubleshooting* ..... 25

    Six- and Four-Wheel Encoders .....25

        Six-Wheel Encoder Normal Operation ..... 25

        Four-Wheel Encoder Normal Operation .....25

        Troubleshooting .....26

    Contact Information ..... 26

        By Phone .....26

        By Fax .....27

        By Email ..... 27

*Appendix A: E-CODER®)R900i™ Flags* ..... 29

    Description of Flags ..... 29

*Glossary* ..... 31

*Index* ..... 33



Figure 1 – E-CODER®)R900i™	1
Figure 2 – Inside Dimensions	4
Figure 3 – Antenna Dimensions	4
Figure 4 – E-CODER®)R900i™ Antenna	7
Figure 5 – Insert the Antenna into the Pit Lid	8
Figure 6 – Locking Nut on Antenna	8
Figure 7 – Secure the Locking Nut	8
Figure 8 – Installation Complete	9
Figure 9 – Remove the Protective Cap and Gasket	9
Figure 10 – Align the F Connector	9
Figure 11 – Seat the Connection	10
Figure 12 – Solar Panel for the E-CODER®)R900i™	11
Figure 13 – Activating the E-CODER®)R900i™	11
Figure 14 – HHU Home Screen	15
Figure 15 – N_SIGHT® R900 Menu Screen	16
Figure 16 – Data Logger Option	16
Figure 17 – Reader ID Input	17
Figure 18 – HHU Time Confirmation	17
Figure 19 – Initialize RF Device	18
Figure 20 – Enter MIU ID	18
Figure 21 – Capture Button	19
Figure 22 – Unit of Measure and Meter Size	19
Figure 23 – Start Button	20
Figure 24 – E-CODER®)R900i™ Listens for Data	20
Figure 25 – E-CODER®)R900i™ Receives Data	21
Figure 26 – Graph Button	21
Figure 27 – Example Data Logging Graphs	22

## Figures

---

Figure 28 – HHU Home Screen .....	23
Figure 29 – HHU Menu .....	23
Figure 30 – Off Cycle Option .....	24

Table 1 – E-CODER®)R900i™ Specifications .....	3
Table 2 – Icons and Displays .....	12
Table 3 – Causes of Leaks .....	13
Table 4 – Data Logging Graph Legend .....	22
Table 5 – Example Reading Values .....	26
Table 6 – Eighth Digit Resolution by Meter Size .....	29
Table 7 – E-CODER®)R900i™ Flags .....	29

This page intentionally left blank.

## Chapter 1: Product Description

This chapter provides a general description of the Neptune® E-CODER®)R900i™ register. The E-CODER)R900i is an integrated register containing both the E-CODER® and R900® technologies in one register that collects meter data. It then transmits the data that a meter reader collects. A Neptune walk-by, mobile, R900 Gateway® fixed network data collection system, or LoRa® fixed network collection system receives the data and stores it to download into the utility billing system for processing.

The E-CODER)R900i is easily installed and operates within a radio frequency (RF) band which does not require an operating license. The E-CODER)R900i meets FCC regulations part 15.247 allowing higher output power and greater range. It uses frequency-hopping spread spectrum technology to avoid RF interference and enhance security. The transmitted data is updated at 15-minute intervals and transmits a mobile message that includes the meter reading data and the unique E-CODER)R900i ID every 14-20 seconds. This allows the meter to be read by a hand-held unit (HHU) or mobile data collections unit.

The E-CODER)R900i also transmits a high-power fixed network message every seven and one-half minutes on an interleaved basis to an R900 Gateway. If connected to a LoRa network, the E-CODER)R900i can transmit a high-power fixed network message every three hours on an interleaved basis.

The E-CODER)R900i is designed to offer advantages to utility organizations of all sizes:

- Increases meter reading accuracy
- Eliminates hard-to-read meters
- Protects utility liability by increasing meter reader safety
- Requires no external wiring or programming
- Provides enhanced eight-digit AMR meter reading
- Provides proactive customer service benefits (leak, tamper, and backflow detection)



Figure 1 – E-CODER®)R900i™

## E-CODER<sup>®</sup>)R900i™ Programming

---

The E-CODER)R900i is NOT field-programmable. At the factory, each of the following items is programmed into the Meter Interface Unit (MIU):

- Serial number - each MIU is given a unique serial number / identification number
- Meter size and change gear information

This chapter defines the specifications for the E-CODER®)R900i™.

### Electrical Specifications

The following table defines the specifications for the E-CODER R900i.

**Table 1 – E-CODER®)R900i™ Specifications**

Specification	Description
Power	Lithium battery
<b>Transmitter Specifications</b>	
Transmit Period	<ul style="list-style-type: none"> <li>• Every 14 to 20 seconds – standard R900 mobile message</li> <li>• Every seven and one-half minutes – standard R900 fixed network message</li> <li>• Every three hours – standard LoRa® fixed network message</li> </ul>
Transmitter Channels	<ul style="list-style-type: none"> <li>• 50 for R900 mobile and fixed</li> <li>• 64 for LoRa fixed network message</li> </ul>
Channel Frequency	902-928 MHz
Output Power	Meets FCC Part 15.247
FCC Verification	Part 15.247
<b>Environmental Conditions</b>	
Operating Temperature	-22° to 149°F (-30° to 65°C)
Storage Temperature	-40° to 158°F (-40° to 70°C)
Operating Humidity	0 to 100% Condensing (pit only)
<b>Functional Specifications</b>	
Register Reading	<ul style="list-style-type: none"> <li>• Eight digits (AMR)</li> <li>• Nine digits (Visual)</li> </ul>
MIU ID	<ul style="list-style-type: none"> <li>• Nine digits (R900 v5)</li> <li>• 10 digits (R900 v4)</li> </ul>
<b>Dimensions and Weight</b>	
Dimensions	Refer to the figures on the following page.
Weight	<ul style="list-style-type: none"> <li>• Inside – 1.39 lbs. (630.5 grams)</li> <li>• Pit – 1.62 lbs. (734.8 grams)</li> </ul>

## E-CODER®R900i™ Dimensions

The following diagrams show both the inside and antenna dimensions for the E-CODER®R900i.

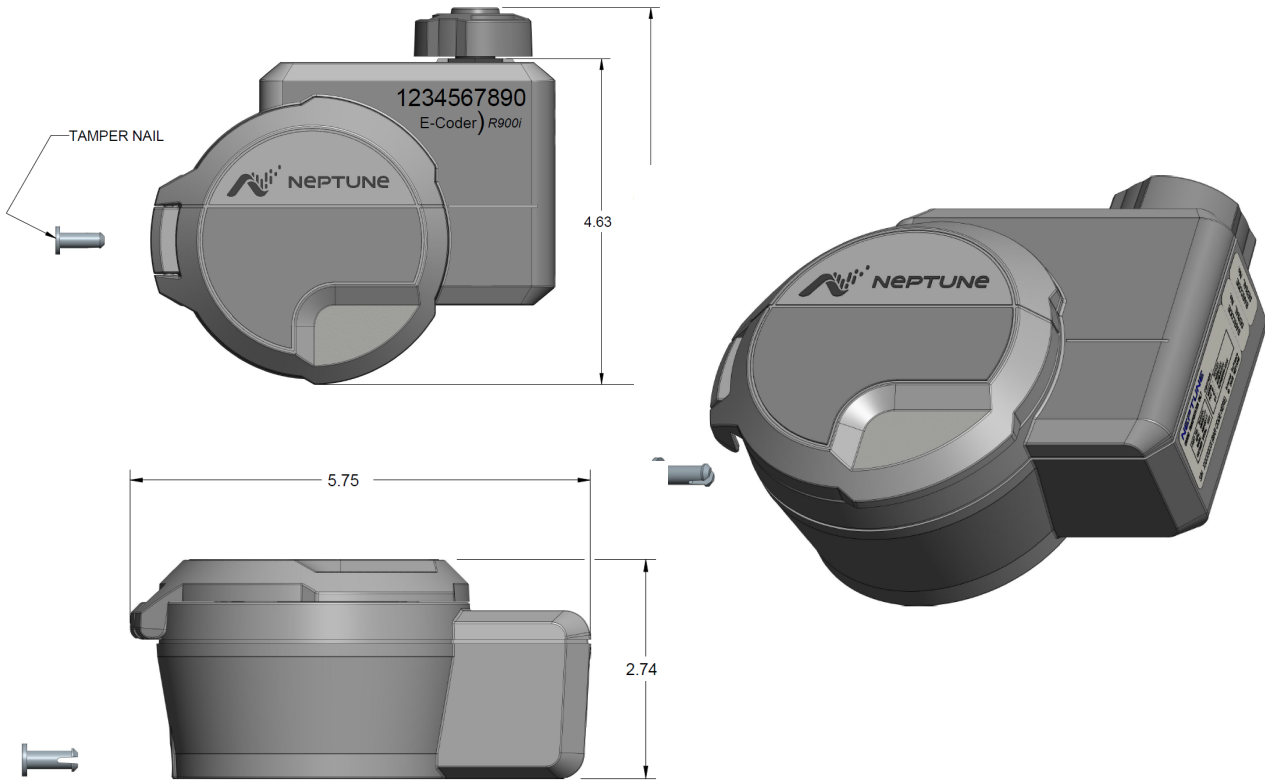

Figure 2 – Inside Dimensions

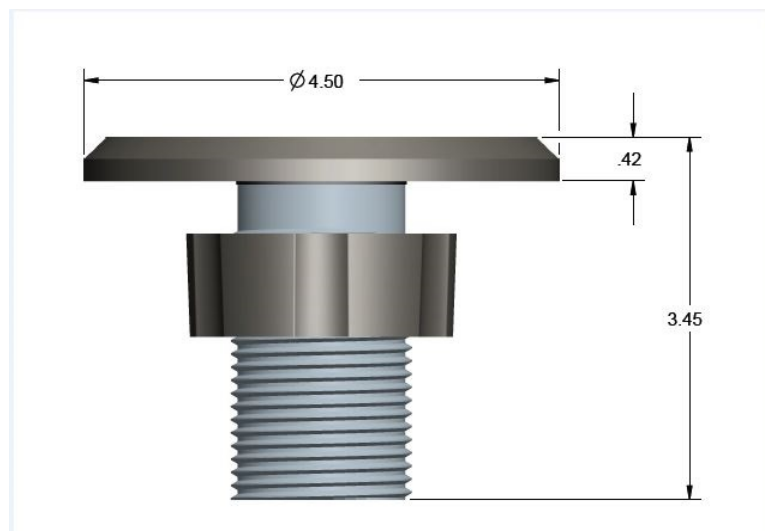

Figure 3 – Antenna Dimensions



This chapter provides instructions for:

- Storing and unpacking the E-CODER®)R900i™
- Performing preliminary tests
- Verifying materials
- Selecting a site
- Installing the unit

### Prior to Installation

---

This section defines how to unpack and store the E-CODER)R900i prior to installing it.

#### Storage

---

After receipt, inspect all shipping containers for damage, and inspect the contents of any damaged cartons prior to storage.

After completing the inspection, store the cartons in a clean, dry environment. The unit remains in sleep mode until it is exposed to light.

#### Unpacking

---

As with all precision electronic instruments, handle the E-CODER)R900i carefully; however, no additional special handling is required. When shipped, the assembly is lying on its side. You should lift the assembly out of the box by the meter main case.

After unpacking the E-CODER)R900i, inspect it for damage. If the E-CODER)R900i appears to be damaged or proves to be defective upon installation, notify your Neptune Territory Manager or Distributor. If one or more items requires reshipment, use the original cardboard box and packing material.

### Safety and Preliminary Checks

---

Observe the following safety and preliminary checks before and during each installation:

- Verify that you are at the location specified on the site work order.
- Verify that the site is safe for you and your equipment.
- Notify the customer of your presence, and tell the customer that you need access to the water meter.
- If the site work order does not have an MIU ID number on it, write in the ID number of the MIU you are about to install. If the site work order already has an MIU ID number on it, verify that it matches the ID number on the MIU you are about to install.

## Site Selection

---

Installation and operation in moderate temperatures increase reliability and product life. See “Environmental Conditions” on page 3.

Follow these guidelines when selecting a location to install the E-CODER)R900i:

- Install the unit in a vertical and upright position.
- Clear all obstructions from the installation location.



Always follow your company's safety practices and installation guidelines when installing an E-CODER. Never install a unit during a lightning storm or under excessively wet conditions.

## Installing the E-CODER®)R900i™

---

Follow the steps in this section for a new or retrofit installation.

### New Meter Installation

---

Follow these steps to perform a new meter installation.

1. Flush the service line prior to installation to remove debris in the line.
2. Place an electrical grounding strap on the service line, connecting the inlet and outlet service lines on either side of the meter setting.



You must install inlet and outlet meter valves and couplings / setters if they are not already present. Allow appropriate space in the line for the meter laying length and two coupling gaskets. Align the pipe ends so that the coupling and meter threads can engage without binding or cross-threading.

3. Before installing the meter, remove the thread protectors and spud caps. Be sure that no debris enters the meter during installation.



Use caution; the meter threads are sharp.

4. Place the coupling gaskets inside the coupling nuts and set the meter in the line. Position The meter horizontally with the register dial facing up. The direction of flow marked on the meter must agree with the direction of water flow.
5. Start the coupling nuts by hand then use a wrench and tighten sufficiently to prevent leakage. Be careful not to cross-thread the connections.

6. Open the meter outlet valve slowly. Open a down stream faucet and run enough water to dissipate entrained air and flush the line. While the faucet is open, verify the meter is operating correctly.
7. Turn off the faucet and check the meter installation for leaks. See "Activating and Reading the E-CODER®)R900i™" on page 11.

## Retrofit Meter Installation

Follow these steps to perform a retrofit meter installation.

1. Use a punch / screwdriver and hammer to punch out the tamper-proof seal pin on the existing register head.
2. Remove the existing register by twisting counter-clockwise.
3. Twist the new E-CODER®)R900i register head clockwise onto the meter body to install it.
4. Snap the new tamper-proof seal pin to secure the register to the meter body.

## Connecting the E-CODER®)R900i™ Through-the-Lid Antenna

When ordering an external antenna for the E-CODER®)R900i unit, Neptune recommends at least a 6-foot cable to allow for easy removal of the pit lid when necessary.

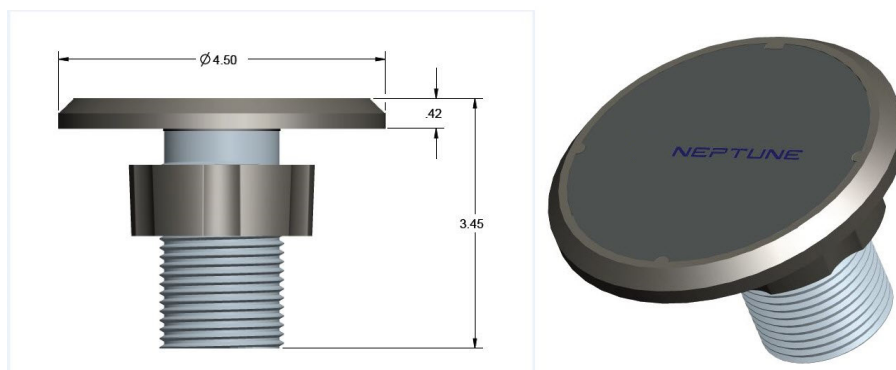

Figure 4 – E-CODER®)R900i™ Antenna

## Installing the Antenna

---

Follow these steps to install the antenna for the E-CODER)R900*i*.

1. Insert the antenna cable and housing through the 1-3/4" hole in the meter pit lid.



Figure 5 – Insert the Antenna into the Pit Lid

2. Thread the locking nut onto the antenna, smooth end toward lid.



Figure 6 – Locking Nut on Antenna

3. Hand tighten the nut securely to the lid.



Figure 7 – Secure the Locking Nut

This figure shows a completed installation of the antenna.



Figure 8 – Installation Complete

## Attaching the Antenna to the MIU

Follow these steps to attach the antenna to the MIU.

1. Remove the protective cap and gasket. If you are replacing an existing antenna, remove the existing antenna connection and clean any dirt, debris, or dielectric grease from the F connector on the MIU housing.



Figure 9 – Remove the Protective Cap and Gasket

2. Carefully align the F connector center conductor and insert the quick connect cable connector into the F connector on the MIU housing.



Figure 10 – Align the F Connector

3. Push the connector in and turn clockwise until the quick connect antenna connection is properly seated on the three-lobed black plastic latch plate.



Figure 11 – Seat the Connection

## Chapter 4: Activating and Reading the E-CODER®)R900i™

This chapter defines how to read the E-CODER®)R900i™ to identify water leaks.

### Activating the LCD Using the Solar Panel

The E-CODER has a solar panel to power the Liquid Crystal Display (LCD).

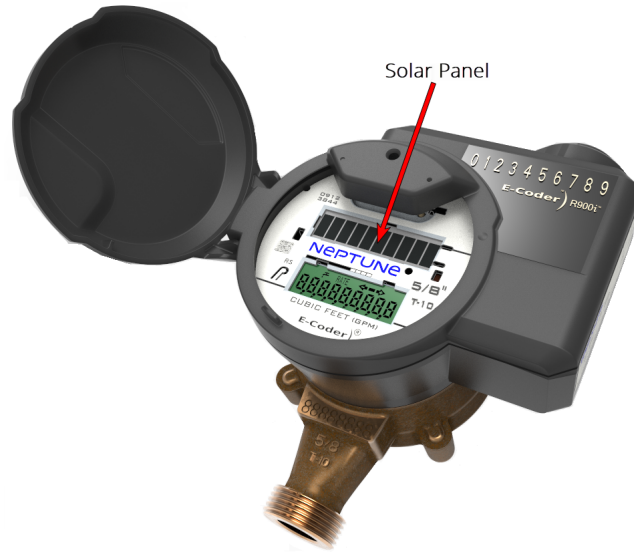

Figure 12 – Solar Panel for the E-CODER®)R900i™

The solar panel activates the LCD display when the unit is exposed to a light source. If the LCD does not reactivate as expected, shine a flashlight on the light sensor.

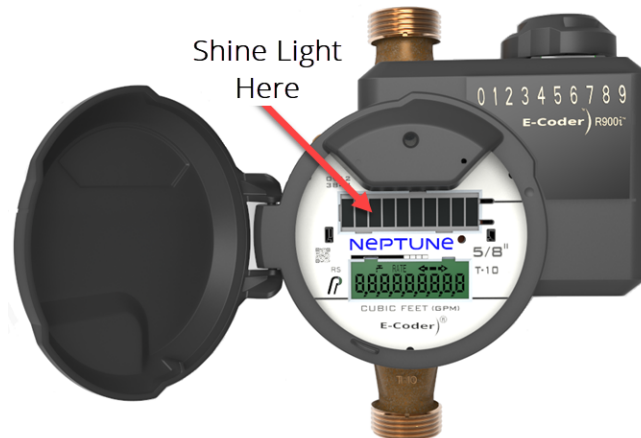

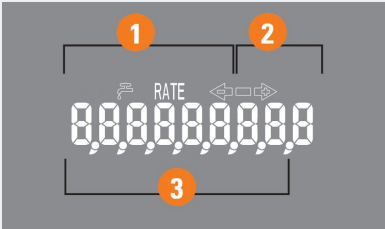

Figure 13 – Activating the E-CODER®)R900i™

## Read the Meter

The following table defines the information the meter presents.

Table 2 – Icons and Displays

Icon	Description
	Flow / Leak Indicator shows the direction of flow through the meter:
	ON Water in use.
	OFF Water not in use.
	Leak indicator displays a possible leak:
	OFF No leak indicated.
	Flashing Intermittent leak indicated. Water used during at least 50 of the 96 days of 15-minute intervals, during the previous 24-hour period.
	Continuous ON Continuous leak indicated. Water used during all 96 days of 15-minute intervals, during the previous 24-hour period.
	<p>Nine-digit LCD displays the meter reading in billing units of measure. The number displays in odometer style, reading left to right:</p> <ul style="list-style-type: none"> <li>• First four digits – typical billing digits.</li> <li>• Last three digits – testing units used for meter testing.</li> <li>• Fifth and sixth reading digits – reading units.</li> </ul>



## Common Causes of Leaks

If the E-CODER)R900i leak indicator is flashing or continuously on, it indicates a possible leak. The following table defines common causes of leaks.

Table 3 – Causes of Leaks

Possible Cause of Leak	Intermittent Leak	Continuous Leak
Outside faucet, garden hose, or sprinkler system leaking	✓	✓
Toilet valve not sealed properly	✓	✓
Toilet running		✓
Faucet in kitchen or bathrooms leaking	✓	✓
Ice maker leaking		✓
Soaker hose in use		✓
Leak between the water meter and the house		✓
Washing machine leaking	✓	✓
Dishwasher leaking	✓	✓
Hot water heater leaking		✓
Yard watered for more than eight hours	✓	✓
Continuous pet water device in use		✓
Water-cooled air conditioner or heat pump	✓	✓
Swimming pool filled		✓
Other continuous use of water for 24 hours		✓

## How to Tell if Water is in Use

---

To determine if water is in use, complete the following steps:

1. Check the flow indicator  by closely watching it for two minutes.
2. Determine the following conditions. If the arrow is:
  - Flashing, then water is running very slowly.
  - Continuously ON, water is running.
  - Not flashing, water is not running.

## What to Do if There is a Leak

---

If the E-CODER)R900i detects a leak, check the following to identify the leak source:

- All faucets
- Toilets and valves
- Ice maker and water dispenser
- Yard sand surrounding grounds for a wet spot indicating a leaking pipe

## If a Continuous Leak is Repaired

---

If a continuous leak is found and repaired, complete the following steps.

1. Do not use any water for at least 15 minutes.
2. Check the leak icon .

If the leak indicator changes from continuous ON to flashing, then a continuous leak is no longer indicated.

## If an Intermittent Leak is Repaired

---

If an intermittent leak is found and repaired, check the leak icon  after at least 24 hours. If the leak has been correctly repaired, the leak icon changes from flashing to OFF.

### About Data Logging

The E-CODER®)R900i™ can store interval data for data logging, and retrieve this data through RF activation. You activate the E-CODER)R900i using the Trimble® Nomad® and R900® Belt Clip Transceiver (BCT).

The E-CODER R900i stores consumption in hourly intervals for a rolling total of 96 days. This is equal to 2,304 hourly intervals of consumption. The log data is extracted through radio frequency (RF) activation. The RF activation allows the utility workers to visit the location and extract the data without physically interacting with the meter itself. This limits worker exposure to animals, or dangerous situations.

The extraction process takes about 30 seconds. Activation is done through the Hand-Held Unit (HHU) connected to the R900 BCT, using Bluetooth. The R900 BCT sends the activation signal to the E-CODER)R900i, which in turn sends the data intervals to the R900 BCT and saves them in the HHU.

### Accessing Data Logging

Complete the following steps to log data.

1. On the host software home screen on the HHU, click **MENU**.



Figure 14 – HHU Home Screen

2. On the HHU Menu screen, click UTILS (option 4).

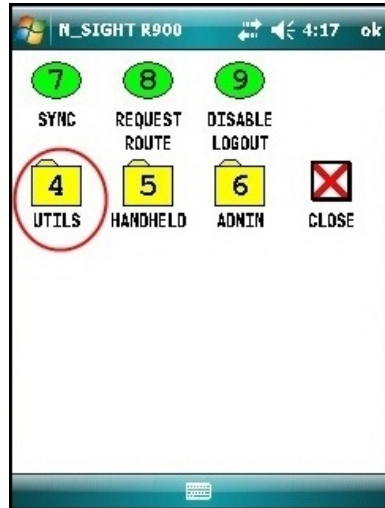

Figure 15 – N\_SIGHT®R900 Menu Screen

3. Click DATA LOGGER (option 9).

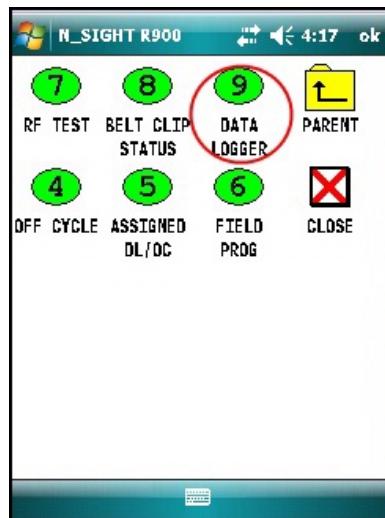

Figure 16 – Data Logger Option

4. Type your reader ID and password for the host software, and then click **LOGIN**.

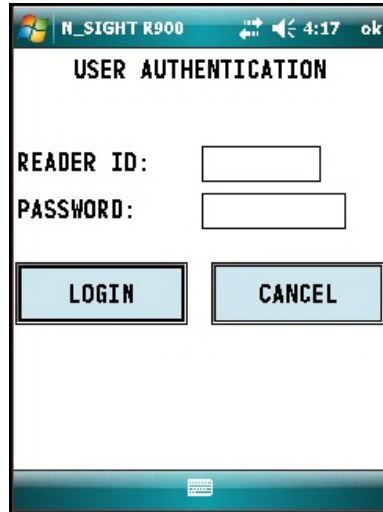

Figure 17 – Reader ID Input

5. Verify the time is correct, and then click **YES**.

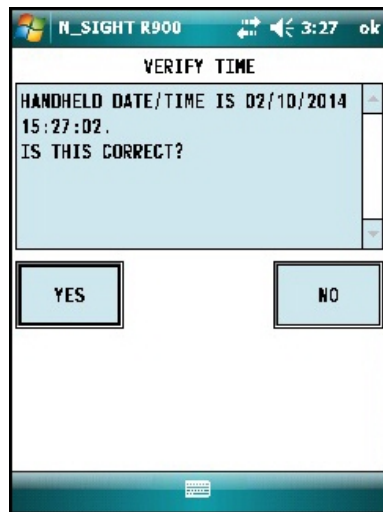

Figure 18 – HHU Time Confirmation



The HHU must be synchronized prior to data logging, to set the clock.

6. The Initialize Device screen appears, if you are not connected or are not in range of your Belt Clip. Click **INITIALIZE**.

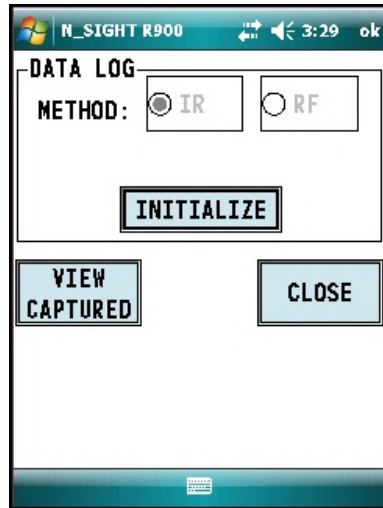

Figure 19 – Initialize RF Device

7. Select **RF**, and then type the MIU ID. You can type the MIU ID using the number pad keys or expand the on-screen keyboard.

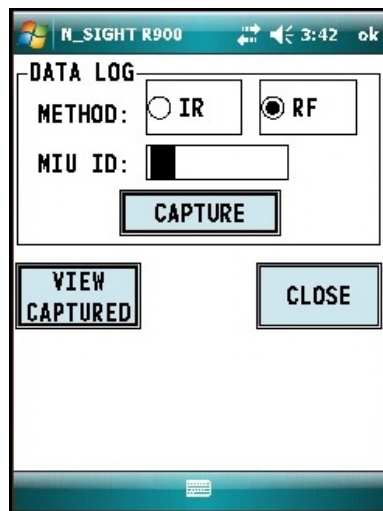

Figure 20 – Enter MIU ID

- After you type the MIU ID, Click CAPTURE.

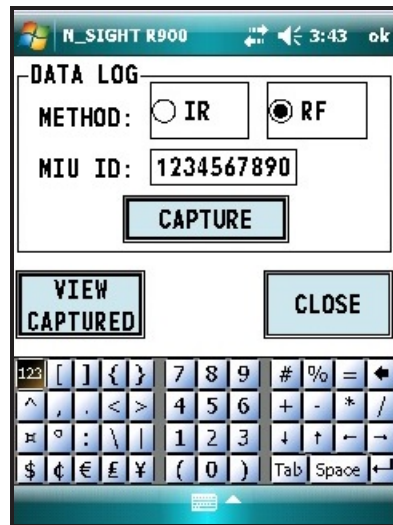

Figure 21 – Capture Button

- Type or select the meter size and information in the appropriate fields, and then click OK.

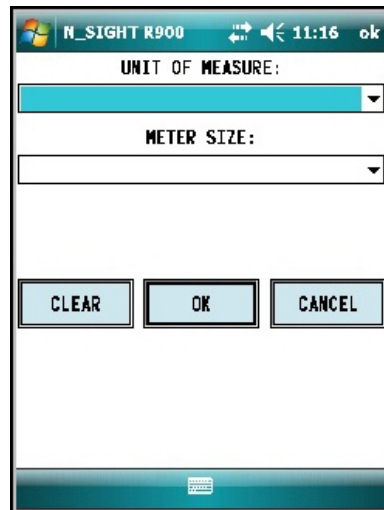

Figure 22 – Unit of Measure and Meter Size

## Initiating RF Activated Data Logging

Follow these steps to initiate data logging.

1. Click **START** to initiate RF-activated data logging.

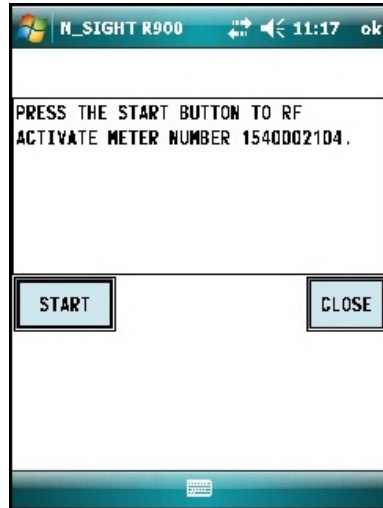

Figure 23 – Start Button

The R900 BCT activates the E-CODER®R900i and listens for the data logger to start transmitting.

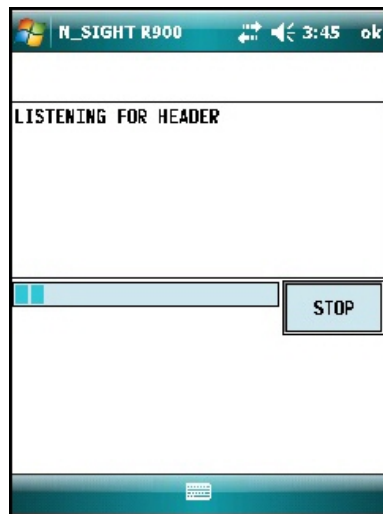

Figure 24 – E-CODER®R900i™ Listens for Data



The screen displays the data received.

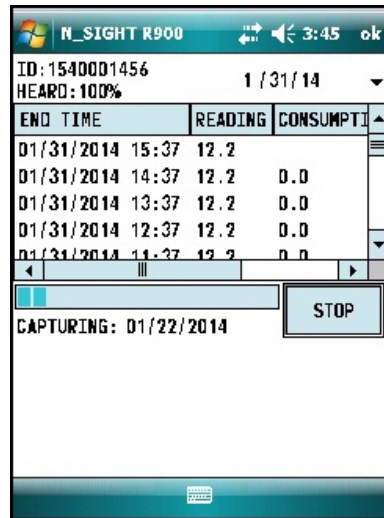

Figure 25 – E-CODER®R900™ Receives Data

2. Choose the meter size.
3. Click **GRAPH** to display the data in a graph. Examples of graphs are shown in Figure 27 on page 22

The HHU processes and saves the data. After closing the data logging screen, the unit performs a backup.

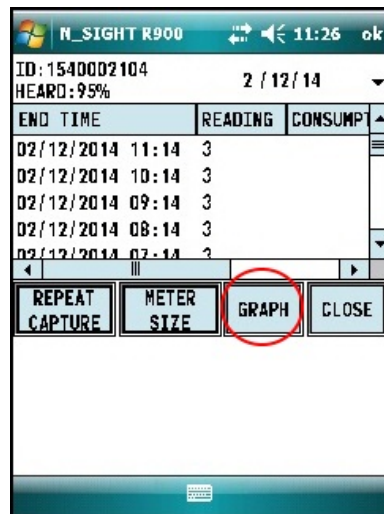

Figure 26 – Graph Button

## Sample Data Logging Graphs

Following are two examples of the graphs that the data logging function produces.

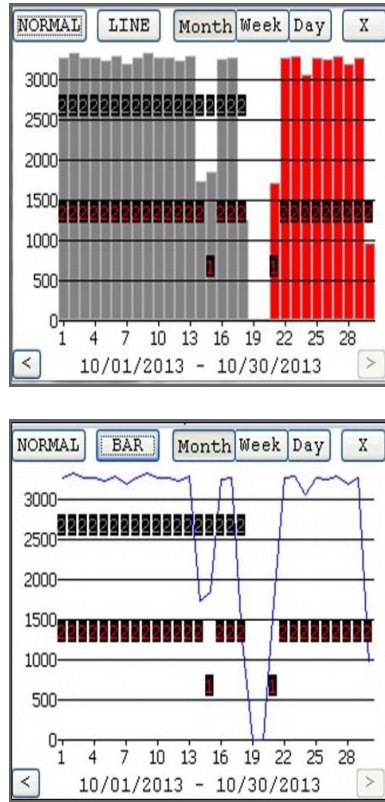

Figure 27 – Example Data Logging Graphs

Table 4 – Data Logging Graph Legend

Color Code	Description
1 Red	Intermittent Leak
2 Red	Continuous Leak
1 Gray	Minor Backflow
2 Gray	Major Backflow
Blue bars	No Flags
Red bars	Leak
Gray bars	Backflow – if the Backflow flag and the Leak flag appear at the same time, Backflow (gray bars) has precedence over Leak.

## Off Cycle Data Extraction

Off-cycle reads are 96 days of daily reads taken at 15-minute intervals over a 24-hour period. This allows the utilities to retrieve move-out reads or monitor vacant usage to prevent theft.

Follow these steps to navigate to the off-cycle function.

1. On the host software home screen on the HHU, click **MENU**.



Figure 28 – HHU Home Screen

2. On the HHU menu screen, click **UTILS** (option 4).

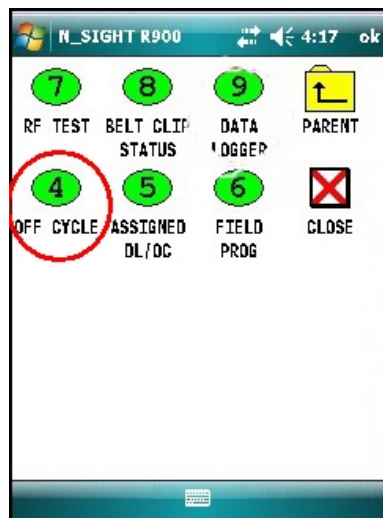

Figure 29 – HHU Menu

3. Click **OFF CYCLE** (option 4).

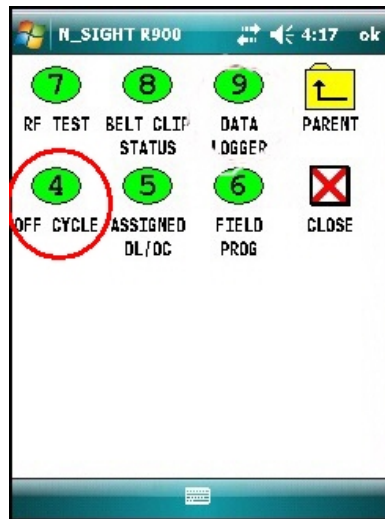

Figure 30 – Off Cycle Option

1. Type the read ID or the password.
2. Click **LOGIN**.
3. Confirm the date and time are correct.
4. Click **YES**.

## Belt Clip Transceiver

---

To pair the Belt Clip Transceiver (BCT), complete the following steps.

1. Change date if you have a specific day to target.
2. Click **INITIALIZE** to pair with R900 BCT.
3. Type the MIU ID.
4. Click **CAPTURE**.

The transceiver captures reads in the same format as the data logger reads. The data logger has 96 days of hourly reads and off cycle has 96 days of daily reads.

## Chapter 6: Maintenance and Troubleshooting

This chapter defines maintenance and troubleshooting procedures for the E-CODER<sup>®</sup>R900i<sup>™</sup>.

### Six- and Four-Wheel Encoders

---

This section defines typical encoder operation and troubleshooting.

#### Six-Wheel Encoder Normal Operation

---

If the odometer reads 123456, the display shows 1 2 3 4 5 5 0 0.



Note that the sixth digit displayed is a five, if the last digit on the odometer is five through nine. The sixth digit is zero if the last digit on the odometer is zero through four. The R900 MIU adds two zeros on the end to provide an eight-digit reading to the host software.

#### Four-Wheel Encoder Normal Operation

---

If the odometer reads 123456, the display shows 1 2 3 4 0 0 0 0.



The R900 MIU adds four zeros on the end to provide an eight-digit reading to the host software.

## Troubleshooting

This section provides examples of possible reading values and what they indicate.

Table 5 – Example Reading Values

Reading Value	Definition	Troubleshooting
.....	Failure to retrieve reading	<ul style="list-style-type: none"> <li>Usually indicates a cut wire. Check the connection between the register and MIU.</li> <li>If using a non-autodetect ProRead™ register, verify that it is programmed for three-wire mode.</li> </ul>
???????	Indicates an ambiguous, bad read, replaces ----- and HHHHHHHH	N/A
MMMMMMMM	Indicates an out-of-range reading (>99999999), diagnostic code from the MIU	<ul style="list-style-type: none"> <li>Indicates that no meter reading history is available.</li> <li>Swipe the MIU with a magnet to force the MIU to read the register.</li> </ul>
UUUUUUUU	Indicates an undefined out of range reading or corrupt valve	N/A

## Contact Information

Within North America, Neptune Customer Support is available Monday through Friday, 7:00 A.M. to 5:00 P.M. Central Standard Time, by telephone, email, or fax.

### By Phone

To contact Neptune Customer Support by phone, complete the following steps.

1. Call **(800) 647-4832**.
2. Select one of the following options:
  - **1** if you have a Technical Support Personal Identification Number (PIN).
  - **2** if you do not have a Technical Support PIN.
3. Enter the six-digit PIN and press #.
4. Select one of the following options.
  - **2** for Technical Support
  - **3** for maintenance contracts or renewals
  - **4** for Return Material Authorization (RMA) for Canadian Accounts

You are directed to the appropriate team of Customer Support Specialists. The specialists are dedicated to you until the issue is resolved to your satisfaction. When you call, be prepared to give the following information:

- Your name and utility or company name.
- A description of what occurred and what you were doing at the time.
- A description of any actions taken to correct the issue.

### By Fax

---

To contact Neptune Customer Support by fax, send a description of your problem to (334) 283-7497. Please include on the fax cover sheet the best time of day for a customer support specialist to contact you.

### By Email

---

To contact Neptune Support by email, send your message to [support@neptunetg.com](mailto:support@neptunetg.com).

This page intentionally left blank.



## Description of Flags

The tables in this appendix describe the volume represented by the eighth digit by meter size, and the flags used the by the E-CODER®)R900i™.

**Table 6 – Eighth Digit Resolution by Meter Size**

Register Size	Eighth Digit Resolution – Least Significant Digit
Residential (5/8" - 1" T-10)	1/10 Gallon or 1/100 Cubic foot
Light Commercial and Industrial (1-1/2" and 2" T-10; 1-1/2" - 4" HPT)	1 Gallon or 1/10 Cubic foot
Large Commercial and Industrial (6" - 12" HPT, HPPII and TRU/FLO®)	10 Gallons or 1 Cubic foot
Large Commercial and Industrial (16" - 20" HPT)	100 Gallons or 10 Cubic feet

**Table 7 – E-CODER®)R900i™ Flags**

Backflow Flag (Resets After 35 Days)	
Based on reverse movement of the eighth digit. Eighth digit is variable based on the meter size.	
No backflow event	Eighth digit reversed less than one digit
Minor backflow event	Eighth digit reversed more than one digit, up to 100 times the eighth digit
Major backflow event	Eighth digit reversed greater than 100 times the eighth digit

Leak Status Flag (Resets After 35 Days)	
Based on total amount of 15-minute periods recorded in the previous 24-hour period.	
Leak icon off	Eighth digit incremented less than 50 of the 96 days of 15-minute intervals
Flashing leak icon	Eighth digit incremented in 50-95 of the 96 days of 15-minute intervals
Solid leak icon	Eighth digit incremented in all of the 96 days 15-minute intervals
Consecutive Days with Zero Consumption Flag (Resets After 35 Days)	
Number of days the "leak status" was at a minimum value	

## A

---

### antenna (pit)

MIU antenna used for pit installations.

## L

---

### Liquid Crystal Display (LCD)

Component where the meter-reading and value-added icons are displayed.

## M

---

### MIU

Meter Interface Unit

## R

---

### register read time

The default time is 15 minutes for all registers. Custom time is not available.

## S

---

### seal pin

Small, black plastic nail used to secure the E-CODER®)R900i to the meter.

### serial number

Unique identification number given to each MIU at the factory. The default value is the last programmed, plus one. Custom serial numbers are not available.

T

---

transmission time

The time between MIU transmissions.

## A

---

activate, solar panel 11

air conditioner, leaks 13

## B

---

backflow 30

## C

---

common causes of leaks 13

customer support 26

## D

---

damage, in shipping 5

data logging, about 15

dimensions 4

    inside 4

    pit 4

dishwasher, leaks 13

## E

---

E-CODER®)R900i

    general description 1

    install inside version 5

    reading 11

    serial number 2

    software for advanced features 14

    specifications 3

    storage 5

    unpacking 5

## F

---

faucet

    kitchen leaks 13

    leaks 13

flashing, indicator 12

## G

---

garden, leaks 13

general description 1

## H

---

heat pump, leaks 13

heating, leaks 13

hose, leaks 13

hot water, leaks 13

## I

---

ice-maker, leaks 13

icon

    LCD 12

    leak 12, 14

indicator

    flashing 12

- possible leak 12
- inspect, E-CODER®)R900i 5
- installation
- preliminary checks 5
- preparing for 13
- site selection, guidelines 6
- site selection, inside version 6

intermittent leak 12, 14

## L

---

LCD display

- 9-digit 12
- activate 11

LCD icon 12

leak icon 12, 14

leak, intermittent indicator 12

leaks

- common causes 13
- found 14
- intermittent 14
- repaired 14

## M

---

maintenance 15

MIU ID number 5

## P

---

pet feeder, leaks 13

possible leaks

- common causes 13

## R

---

R900 Belt Clip Transceiver (BCT) 15

read E-CODER®)R900i 11

return of damaged unit 5

RF

- band 1

## S

---

safety practices 6

serial number 2

software, for advanced features 14

solar panel 11

sprinkler, leaks 13

storage 5

## T

---

testing the installation 15

toilet, leaks 13

## W

---

washing machine, leaks 13

water in use, determine 14





**Neptune Technology Group Inc.**

1600 Alabama Highway 229  
Tallasse, AL 36078  
USA Tel: (800) 633-8754  
Fax: (334) 283-7293

**Neptune Technology Group**

(Canada) Ltd.  
7275 West Credit Avenue  
Mississauga, Ontario L5N 5M9  
Canada Tel: (905) 858-4211  
Fax: (905) 858-0428

**Neptune Technology Group Inc.**

Avenida Ejercito Nacional No 418  
Piso 12, Despacho 1203  
Colonia Polanco V Sección  
C.P. 11560 Delegación, Miguel Hidalgo  
Mexico D.F.  
Tel: (55) 5203-5708, (55) 5203-4032,  
(55) 5203-5294

Online  
[www.neptunetg.com](http://www.neptunetg.com)